

# AUTOMORPHISMS OF THE PANTS COMPLEX

---

DAN MARGALIT

*In loving memory of my mother, Batya*

## 1. Introduction

In the theory of mapping class groups, “curve complexes” assume a role similar to the one that buildings play in the theory of linear groups. Ivanov, Korkmaz, and Luo showed that the automorphism group of the curve complex for a surface is generally isomorphic to the extended mapping class group of the surface. In this paper, we show that the same is true for the pants complex.

Throughout,  $S$  is an orientable surface whose Euler characteristic  $\chi(S)$  is negative, while  $\Sigma_{g,b}$  denotes a surface of genus  $g$  with  $b$  boundary components. Also,  $\text{Mod}(S)$  means the *extended mapping class group* of  $S$  (the group of homotopy classes of self-homeomorphisms of  $S$ ).

The pants complex of  $S$ , denoted  $C_P(S)$ , has vertices representing pants decompositions of  $S$ , edges connecting vertices whose pants decompositions differ by an elementary move, and 2-cells representing certain relations between elementary moves (see Sec. 2). Its 1-skeleton  $C_P^1(S)$  is called the *pants graph* and was introduced by Hatcher and Thurston. We give a detailed definition of the pants complex in Section 2.

Brock proved that  $C_P^1(S)$  models the Teichmüller space endowed with the Weil-Petersson metric,  $\mathcal{T}_{WP}(S)$ , in that the spaces are quasi-isometric (see [1]). Our results further indicate that  $C_P^1(S)$  is the “right” combinatorial model for  $\mathcal{T}_{WP}(S)$ , in that  $\text{Aut } C_P^1(S)$  (the group of simplicial automorphisms of  $C_P^1(S)$ ) is shown to be  $\text{Mod}(S)$ . This is in consonance with the result of Masur and Wolf that the isometry group of  $\mathcal{T}_{WP}(S)$  is  $\text{Mod}(S)$  (see [10]).

There is a natural action of  $\text{Mod}(S)$  on  $C_P^1(S)$ ; we prove that *all* automorphisms of  $C_P^1(S)$  are induced by  $\text{Mod}(S)$ . The results of this paper can be summarized as follows:

$$\text{Aut } C_P(S) \cong \text{Aut } C_P^1(S) \cong \text{Mod}(S)$$

for most surfaces  $S$ .

DUKE MATHEMATICAL JOURNAL

Vol. 121, No. 3, © 2004

Received 12 September 2002. Revision received 28 March 2003.

2000 *Mathematics Subject Classification*. Primary 57M; Secondary 20F.

THEOREM 1

If  $S \neq \Sigma_{0,3}$  is an orientable surface with  $\chi(S) < 0$ , and  $\theta : \text{Mod}(S) \rightarrow \text{Aut } C_P(S)$  is the natural map, then

- $\theta$  is surjective;
- $\ker(\theta) \cong \mathbb{Z}_2$  for  $S \in \{\Sigma_{1,1}, \Sigma_{1,2}, \Sigma_{2,0}\}$ ,  $\ker(\theta) \cong \mathbb{Z}_2 \oplus \mathbb{Z}_2$  for  $S = \Sigma_{0,4}$ , and  $\ker(\theta)$  is trivial otherwise.

In short, Theorem 1 says that the natural map  $\theta$  is an isomorphism for most  $S$ . The nontrivial kernels in Theorem 1 are generated by hyperelliptic involutions (see [8]). Note that  $C_P(\Sigma_{0,3})$  is empty.

THEOREM 2

If  $S$  is an orientable surface with  $\chi(S) < 0$ , then

$$\text{Aut } C_P(S) \cong \text{Aut } C_P^1(S).$$

In terms of simplicial automorphisms, Theorem 2 says that the pants complex carries no more information than its 1-skeleton.

In order to prove Theorem 1, we apply the corresponding theorem for a different simplicial complex, the curve complex.

THEOREM 3 (Ivanov, Korkmaz, Luo)

If  $S \neq \Sigma_{0,3}$  is an orientable surface with  $\chi(S) < 0$ , and  $\eta : \text{Mod}(S) \rightarrow \text{Aut } C(S)$  is the natural map, then

- $\eta$  is surjective when  $S \neq \Sigma_{1,2}$ ;
- $\ker(\eta) \cong \mathbb{Z}_2$  for  $S \in \{\Sigma_{1,1}, \Sigma_{1,2}, \Sigma_{2,0}\}$ ,  $\ker(\eta) \cong \mathbb{Z}_2 \oplus \mathbb{Z}_2$  for  $S = \Sigma_{0,4}$ , and  $\ker(\eta)$  is trivial otherwise;
- $\text{Im}(\eta) = \text{Aut}^* C(S) \cong \text{Aut } C(S)$  when  $S = \Sigma_{1,2}$ .

In the theorem,  $C(S)$  is the curve complex for  $S$  (defined in Sec. 2), and  $\text{Aut}^* C(S)$  is the subgroup of  $\text{Aut } C(S)$  which preserves the set of vertices of  $C(S)$  representing nonseparating curves. The surjectivity statement implies that  $\text{Aut } C(S)$  is the same as  $\text{Aut}^* C(S)$  for  $S \neq \Sigma_{1,2}$ . The reason  $\Sigma_{1,2}$  is exceptional is that it has a hyperelliptic involution  $\rho$  with the property that the projection  $\Sigma_{1,2} \rightarrow \Sigma_{1,2}/\langle \rho \rangle \sim \Sigma_{0,5}$  is an isomorphism on curve complexes, but  $\text{Mod}(\Sigma_{1,2})/\ker(\eta) \not\cong \text{Mod}(\Sigma_{0,5})$ .

Theorem 3 for  $S \neq \Sigma_{1,2}$  is originally due to Ivanov for high genus (see [6]) and Korkmaz for low genus (see [7]). Luo gave a new proof for all genera and also settled the case of  $S = \Sigma_{1,2}$  (see [8]).

Theorem 1 is a refinement of Theorem 3 for two reasons. First,  $C_P^1(S)$  is a thin subcomplex of the dual of  $C(S)$ , so a priori it has more automorphisms. Also, there

are no exceptional cases to the surjectivity statement in Theorem 1.

The key idea for the proof of Theorem 1 is that there is a correlation between marked Farey graphs in  $C_P^1(S)$  and vertices in  $C(S)$ . An automorphism of  $C_P^1(S)$  induces a permutation of these Farey graphs, and hence it gives rise to an automorphism of  $C(S)$ , at which point Theorem 3 applies.

Theorem 2 actually follows from Theorem 1. However, we give an independent, elementary proof in Section 4. We show that the 2-cells of  $C_P(S)$ , which are defined via topological relationships on the surface  $S$ , can equivalently be characterized using only the combinatorics of  $C_P^1(S)$ . For example, square 2-cells of  $C_P(S)$  are originally defined as a commutator of two moves on disjoint subsurfaces on  $S$  (see Fig. 4). We prove that square 2-cells can equivalently be defined as loops with four edges in  $C_P^1(S)$  which have the property that consecutive edges do not lie in a common Farey graph. Note that in the second definition there is no reference to  $S$ , only  $C_P^1(S)$ . Therefore any automorphism of  $C_P^1(S)$  must preserve these square 2-cells of  $C_P(S)$ .

## 2. The complexes

### 2.1. Curve complex

*Curves.* A simple closed curve on  $S$  (homeomorphic embedding of the circle) is *non-trivial* if it is *essential* (not null homotopic) and *nonperipheral* (not homotopic to a boundary component). Throughout, we use *curve* to mean *homotopy class of simple closed curves*.

Any mention of *intersection* between two curves  $\alpha$  and  $\beta$  refers to the *geometric intersection number*  $i(\alpha, \beta)$  (the minimum number of intersection points between two representative curves of the respective homotopy classes).

*Curve complex.* The *curve complex* of  $S$  is an abstract simplicial complex denoted  $C(S)$  with vertices corresponding to nontrivial (homotopy classes of simple closed) curves on  $S$ .

A set of  $k + 1$  vertices is the 0-skeleton of a  $k$ -simplex in  $C(S)$  if there are representative curves from the corresponding curve classes which are simultaneously disjoint. For example, edges correspond to pairs of disjoint curves.

It is a standard fact that if a set of homotopy classes of curves have pairwise intersection number zero, then there is a single set of representative curves that are simultaneously disjoint. In other words, every complete graph on  $k + 1$  vertices in  $C(S)$  is the 1-skeleton of a  $k$ -simplex in  $C(S)$ . One way to see this is to fix a hyperbolic metric on  $S$  and take the representative curves to be the unique geodesics in each homotopy class.

The curve complex was first defined by Harvey [3]. Harer proved that it is homotopy equivalent to a wedge of spheres (see [2]). Ivanov used the theorem that  $\text{Aut } C(S) \cong \text{Mod}(S)$  to give a new proof of Royden's theorem that  $\text{Isom}(\mathcal{T}(S)) \cong \text{Mod}(S)$  (where  $\mathcal{T}(S)$  is the Teichmüller space of  $S$  with the Teichmüller metric) (see [6]). Masur and Minsky showed that  $C(S)$  is  $\delta$ -hyperbolic (see [9]).

The curve complex has an altered definition in two cases. For  $\Sigma_{0,4}$  and  $\Sigma_{1,1}$ , since there is no pair of distinct simple closed curves with intersection number zero, two vertices are connected by an edge when the curves they represent have minimal intersection (2 in the case of  $\Sigma_{0,4}$ , and 1 in the case of  $\Sigma_{1,1}$ ). It turns out that in both cases, the curve complex is a modular configuration or *Farey graph* (see Fig. 1) (see [11]).

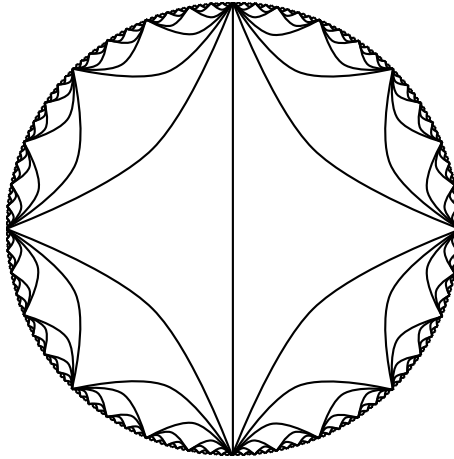

Figure 1. A Farey graph

## 2.2. Pants complex

*Pants decompositions.* A *pants decomposition* of  $S$  is a maximal collection of distinct nontrivial simple closed curves on  $S$  which have pairwise intersection number zero. In other words, pants decompositions correspond to maximal simplices of the curve complex. A pants decomposition always consists of  $3g - 3 + b$  curves (where  $S = \Sigma_{g,b}$ ). The complement in  $S$  of the curves of a pants decomposition is  $2g - 2 + b$  thrice punctured spheres or *pairs of pants*. A pants decomposition is written as  $\{\alpha_1, \dots, \alpha_n\}$ , where the  $\alpha_i$  are curves on  $S$ .

*Elementary moves.* Two pants decompositions  $p$  and  $p'$  of  $S$  differ by an *elementary*

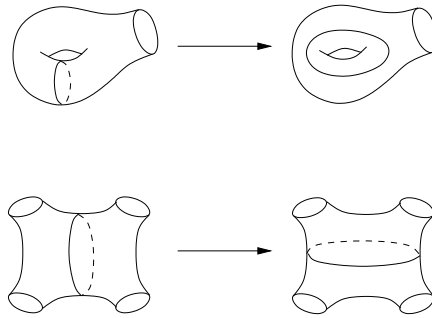

Figure 2. Elementary moves between pants decompositions

move if  $p'$  can be obtained from  $p$  by replacing one curve in  $p$ , say,  $\alpha_1$ , with another curve, say,  $\alpha'_1$ , such that  $\alpha_1$  and  $\alpha'_1$  intersect *minimally*. If  $\alpha_1$  lies on a  $\Sigma_{0,4}$  in the complement of the other curves in  $p$ , then “minimally” means  $i(\alpha_1, \alpha'_1) = 2$ ; if  $\alpha_1$  lies on a  $\Sigma_{1,1}$  in the complement of the rest of  $p$ , then it means  $i(\alpha_1, \alpha'_1) = 1$ . These are the only possibilities, corresponding to whether  $\alpha_1$  is the boundary between two pairs of pants on  $S$  or is in a single pair of pants.

An elementary move is denoted  $\{\alpha_1, \dots, \alpha_n\} \rightarrow \{\alpha'_1, \alpha_2, \dots, \alpha_n\}$  or  $\alpha_1 \rightarrow \alpha'_1$ . Note that there are countably many elementary moves of the form  $\alpha_1 \rightarrow \star$ .

*Pants graph.* The *pants graph* of  $S$ , denoted  $C_p^1(S)$ , is the abstract simplicial complex with vertices corresponding to pants decompositions of  $S$ , and edges joining vertices whose associated pants decompositions differ by an elementary move.

Note that the pants graphs for  $\Sigma_{0,4}$  and  $\Sigma_{1,1}$  have the same definitions as (the 1-skeletons of) the curve complexes for these surfaces—all four are Farey graphs (see Fig. 2).

*Pants complex.* The *pants complex* of  $S$ , denoted  $C_P(S)$ , has  $C_p^1(S)$  as its 1-skeleton, and it also has 2-cells representing specific relations between elementary moves which are given by topological data on  $S$ , as depicted in Figures 3–6.

The pants complex was first introduced by Hatcher and Thurston as a tool for constructing a finite presentation of  $\text{Mod}(S)$  (see [5]). Hatcher, Lochak, and Schneps gave the pants complex its present form, and, in particular, they showed that it is connected and simply connected (see [4]).

### 3. Proof of Theorem 1

Let  $S = \Sigma_{g,b}$  ( $\neq \Sigma_{0,3}$ ) be an orientable surface with  $\chi(S) < 0$ , and let  $n = 3g - 3 + b$  be the number of curves in a pants decomposition of  $S$ .

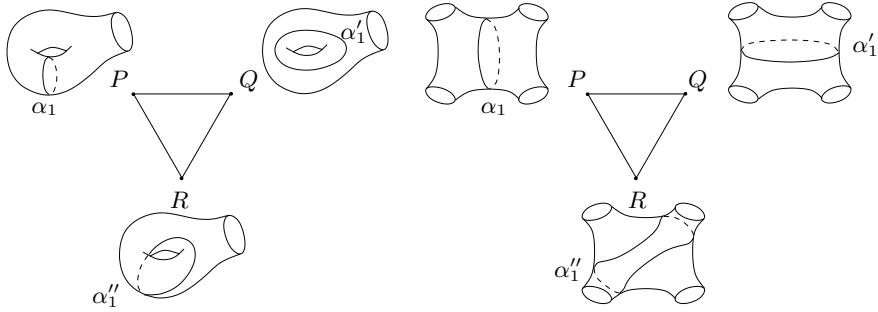

Figure 3. Triangular 2-cells in the pants complex

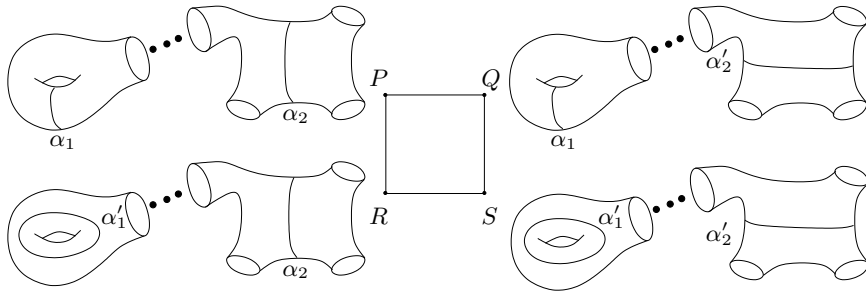

Figure 4. Square 2-cells in the pants complex (moves can be of either type)

*Outline.* The idea for the proof of Theorem 1 is to construct an isomorphism  $\phi$  so that the following diagram commutes:

$$\begin{array}{ccccc}
 \text{Mod}(S) & \xlongequal{\quad} & \text{Mod}(S) & \xlongequal{\quad} & \text{Mod}(S) \\
 \theta \downarrow & & \downarrow & & \downarrow \eta \\
 \text{Aut } C_P(S) & \xrightarrow{\iota} & \text{Aut } C_P^1(S) & \xrightarrow{\phi} & \text{Aut } C(S)
 \end{array}$$

The surjectivity of  $\theta$  (Th. 1) then follows from the surjectivity of  $\eta$  (Th. 3) and the injectivity of the natural map  $\iota$ . Note that  $\iota$  must also be surjective, so  $\iota$  is an isomorphism (Th. 2). The description of  $\ker(\theta)$  (Th. 1) also follows from Theorem 3.

For the case of  $S = \Sigma_{1,2}$ , a separate argument is needed to show that  $\text{image}(\phi) \subset \text{image}(\eta) = \text{Aut}^* C(S)$  (see Sec. 5).

In order to construct  $\phi$ , we develop the following natural surjective map:

$$\{\text{marked abstract Farey graphs in } C_P^1(S)\} \longrightarrow \{\text{vertices of } C(S)\}.$$

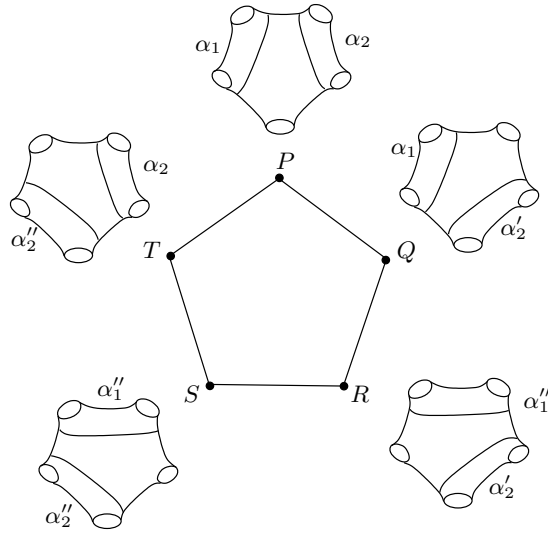

Figure 5. Pentagonal 2-cells in the pants complex

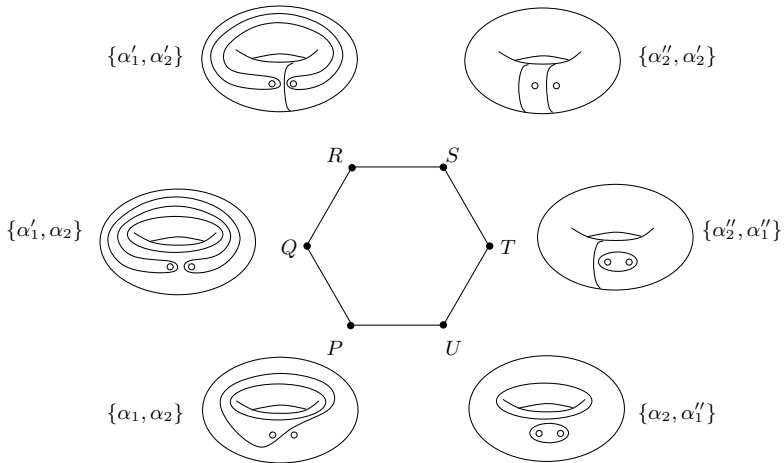

Figure 6. Hexagonal 2-cells in the pants complex

Here, an *abstract Farey graph* is any subgraph of  $C_P^1(S)$  abstractly isomorphic to a Farey graph; and a *marked graph*  $(F, X)$  is a graph  $F$  with a distinguished vertex  $X$ .

### 3.1. Definition of $\phi$

To begin, we completely characterize triangles in  $C_P^1(S)$  since they are the building blocks of Farey graphs. By *triangle*, we mean a subgraph of  $C_P^1(S)$  which is a complete graph on three vertices. The following lemma implies that the three pants decompositions associated to the vertices of any triangle are of the form  $\{\star, \alpha_2, \dots, \alpha_n\}$ .

#### LEMMA 1

*Every triangle in  $C_P^1(S)$  is the boundary of a triangular 2-cell of  $C_P(S)$ .*

#### *Proof*

Suppose that  $P$ ,  $Q$ , and  $R$  are the vertices of a triangle in  $C_P^1(S)$ . Since the pants decompositions associated to  $P$  and  $Q$  differ by an elementary move, they must differ by exactly one curve. Say that  $P$  and  $Q$  are associated to  $\{\alpha_1, \dots, \alpha_n\}$  and  $\{\alpha'_1, \alpha_2, \dots, \alpha_n\}$ . A pants decomposition associated to  $R$  must have exactly  $n - 1$  curves in common with each of these, so it must, in fact, contain  $\alpha_2, \dots, \alpha_n$ . (Otherwise, it would have to contain  $\alpha_1$  and  $\alpha'_1$ , which cannot happen since  $i(\alpha_1, \alpha'_1) > 0$ .) Hence  $R$  is associated to  $\{\alpha''_1, \alpha_2, \dots, \alpha_n\}$  for some  $\alpha''_1$ .

The curves  $\alpha_1$ ,  $\alpha'_1$ , and  $\alpha''_1$  lie on a common subsurface  $S'$  (either a  $\Sigma_{1,1}$  or a  $\Sigma_{0,4}$ ) in the complement of  $\{\alpha_2, \dots, \alpha_n\}$ . Thus the triangle  $PQR$  can be thought of as one of the triangles in  $C_P^1(S')$ , which correspond exactly to triangular 2-cells.  $\square$

By piecing triangles together, we can characterize Farey graphs in  $C_P^1(S)$ .

#### LEMMA 2

*There is a natural surjective map from the set of marked abstract Farey graphs in  $C_P^1(S)$  to the set of vertices of  $C(S)$ .*

#### *Proof*

Let  $(F, X)$  be a marked abstract Farey graph in  $C_P^1(S)$ . Since  $F$  is chain-connected (any two triangles can be connected by a sequence of triangles so that consecutive triangles share an edge), and since the pants decompositions associated to any triangle are of the form  $\{\alpha_1^1, \alpha_2, \dots, \alpha_n\}$ ,  $\{\alpha_1^2, \alpha_2, \dots, \alpha_n\}$ ,  $\{\alpha_1^3, \alpha_2, \dots, \alpha_n\}$ , it follows that there are  $n - 1$  *fixed curves*  $(\alpha_2, \dots, \alpha_n)$  and one *moving curve* (the  $\alpha_1^i$ 's) in the pants decompositions associated to the vertices of  $F$ . The vertex  $X$  distinguishes one of the  $\alpha_1^i$ . Hence there is a unique vertex  $v_{(F,X)}$  of  $C(S)$  corresponding to  $(F, X)$ .

To show that the map defined above is surjective, we now find a marked Farey



graph corresponding to a given vertex  $v$  of  $C(S)$ . If  $v$  is associated to the curve  $\alpha_1$  on  $S$ , then choose a vertex  $X$  of  $C_p^1(S)$  associated to some pants decomposition  $\{\alpha_1, \alpha_2, \dots, \alpha_n\}$  containing  $\alpha_1$ . Since the complement of  $\alpha_2, \dots, \alpha_n$  in  $S$  is a number of pants and either a  $\Sigma_{0,4}$  or  $\Sigma_{1,1}$ , the set of pants decompositions of the form  $\{\star, \alpha_2, \dots, \alpha_n\}$  corresponds to a Farey graph  $F_v \cong C_p^1(\Sigma_{0,4}) \cong C_p^1(\Sigma_{1,1})$  in  $C_p^1(S)$ , and  $(F_v, X)$  corresponds to  $v$ ; that is,  $v_{(F_v, X)} = v$ .  $\square$

By a slight abuse of notation, we say that  $v_{(F, X)}$  corresponds to  $(F, X)$ , and vice versa (even though the map is not bijective).

Now that we have the correspondence of Lemma 2, and we are ready to define the map  $\phi$ .

*Definition of  $\phi$ .* Let  $A \in \text{Aut } C_p^1(S)$ . We define  $\phi(A) : C^{(0)}(S) \rightarrow C^{(0)}(S)$  (and hence  $\phi$ ) by way of saying what  $\phi(A)$  does to each vertex of  $C(S)$ .

If  $v$  is a vertex of  $C(S)$ , and  $(F_v, X)$  is some marked Farey graph in  $C_p^1(S)$  corresponding to  $v$  (recall that there is a choice here), then  $\phi(A)(v)$  is defined to be  $v_{(A(F_v), A(X))}$ , the unique vertex of  $C(S)$  corresponding to the marked Farey graph  $(A(F_v), A(X))$ .

### 3.2. $\phi$ is well defined

In order to show that  $\phi$  is well defined, we require two new concepts: alternating sequences and small circuits.

*Circuits.* A circuit is a subgraph of  $C_p^1(S)$  homeomorphic to a circle. We define *triangles*, *squares*, *pentagons*, and *hexagons* to be circuits with the appropriate number of vertices.

For the definition of alternating below, note that an edge of  $C_p^1(S)$  lies in a unique Farey graph in  $C_p^1(S)$ . This fact follows from the proof of Lemma 2.

*Alternating sequences.* A sequence of consecutive vertices  $P_1 P_2 \dots P_m$  in a circuit is called *alternating* if the unique Farey graph containing the edge  $P_{i-1} P_i$  is not the same as the unique Farey graph containing  $P_i P_{i+1}$  for  $1 < i < m$ . By Lemma 2, an equivalent characterization of alternating is that the pants decompositions associated to  $P_{i-1}$ ,  $P_i$ , and  $P_{i+1}$  have no set of  $n - 1$  curves in common.

A useful working definition of an alternating sequence of vertices  $PQR$  is that if the elementary move corresponding to  $PQ$  is  $\star \rightarrow \alpha$ , then the elementary move corresponding to  $QR$  is not of the form  $\alpha \rightarrow \star$ . A circuit in  $C_p^1(S)$  with the property that any three consecutive vertices make up an alternating sequence is called an *alternating circuit*.

Since alternating sequences are defined in terms of the combinatorics of  $C_p^1(S)$ , we have the following.

LEMMA 3

*Automorphisms of  $C_p^1(S)$  preserve alternating sequences.*

*Small circuits.* A *small circuit* in  $C_p^1(S)$  is a circuit with no more than six edges. We give a partial characterization, which is used to show that the map  $\phi$  is well defined and to prove the results in Section 4.

A *2-curve small circuit* is a circuit with the property that the pants decompositions associated to its vertices all contain the same set of  $n - 2$  curves; that is, they are of the form  $\{\star, \star, \alpha_3, \dots, \alpha_n\}$ . For convenience, small circuits that are subgraphs of Farey graphs are also called *2-curve small circuits* (by Lem. 2 they are really “1-curve small circuits”).

LEMMA 4

*Any small circuit that is not a 2-curve small circuit is an alternating hexagon.*

*Proof*

Let  $\mathcal{L}$  be the small circuit, and say that one of its vertices is associated to the pants decomposition  $p = \{\alpha_1, \alpha_2, \dots, \alpha_n\}$ . Since  $\mathcal{L}$  is not a 2-curve small circuit, then (after picking a direction around  $\mathcal{L}$ ) there must be three edges of  $\mathcal{L}$  corresponding to moves of the form  $\alpha_i \rightarrow \star$ ,  $\alpha_j \rightarrow \star$ , and  $\alpha_k \rightarrow \star$  with  $1 \leq i, j, k \leq n$  distinct. Without loss of generality, we have

$$\alpha_1 \xrightarrow{m_1} \alpha'_1, \quad \alpha_2 \xrightarrow{m_2} \alpha'_2, \quad \alpha_3 \xrightarrow{m_3} \alpha'_3.$$

In order to make  $\mathcal{L}$  a closed loop, there must also be three edges of the form

$$\star \xrightarrow{m'_1} \alpha_1, \quad \star \xrightarrow{m'_2} \alpha_2, \quad \star \xrightarrow{m'_3} \alpha_3.$$

Note that these six moves are distinct. In other words,  $\alpha'_i$  is not  $\alpha_j$  for any  $j$ . This is true because  $i(\alpha'_i, \alpha_i) > 0$  (they differ by an elementary move), while  $i(\alpha_i, \alpha_j) = 0$  (they both appear in the pants decomposition  $p$ ). Since  $\mathcal{L}$  is a small circuit, there are no further edges.

Further, we claim that each  $m'_i$  is given by  $\alpha'_i \rightarrow \alpha_i$ . If, on the contrary, we have, for example, that  $m'_1$  is  $\alpha'_2 \rightarrow \alpha_1$ , then  $i(\alpha'_2, \alpha_1) > 0$  and  $i(\alpha'_2, \alpha_2) > 0$  ( $\alpha'_2$  differs from both by an elementary move). Thus, among the set of curves  $\{\alpha_1, \alpha'_1, \alpha_2, \alpha_3, \alpha'_3\}$ ,  $\alpha'_2$  can appear only in a pants decomposition with  $\alpha'_1, \alpha_3, \alpha'_3$ . So the only possibilities

for  $m'_1$  are

$$\begin{aligned} \{\alpha'_2, \alpha'_1, \alpha_3\} &\xrightarrow{m'_1} \{\alpha_1, \alpha'_1, \alpha_3\}, \\ \{\alpha'_2, \alpha'_1, \alpha'_3\} &\xrightarrow{m'_1} \{\alpha_1, \alpha'_1, \alpha'_3\}, \\ \{\alpha'_2, \alpha'_3, \alpha_3\} &\xrightarrow{m'_1} \{\alpha_1, \alpha'_3, \alpha_3\}, \end{aligned}$$

which are all impossibilities since they each contain a pair  $\alpha_i$  and  $\alpha'_i$ , but  $i(\alpha_i, \alpha'_i) > 0$ . (Note that we ignore the curves  $\alpha_4, \dots, \alpha_n$ , as they must appear in each pants decomposition.)

Now  $\mathcal{L}$  must be alternating because otherwise it has a pair of consecutive edges corresponding to  $m_i$  and  $m'_i$ . □

An immediate consequence of Lemmas 3 and 4 is the following.

LEMMA 5

If  $A \in \text{Aut } C_p^1(S)$ , and  $\mathcal{L}$  is a small circuit that is not an alternating hexagon, then  $A(\mathcal{L})$  is a 2-curve small circuit.

LEMMA 6

The map  $\phi : \text{Aut } C_p^1(S) \longrightarrow \text{Aut } C(S)$  is well defined.

*Proof*

Let  $v$  be a vertex in  $C(S)$  associated to the curve  $\alpha_1$  on  $S$ . We need to show that if  $p$  and  $p'$  are two pants decompositions that give rise to two marked Farey graphs  $(F_v, X)$  and  $(F'_v, X')$  corresponding to  $v$ , then the two vertices of  $C(S)$  corresponding to  $(A(F_v), A(X))$  and  $(A(F'_v), A(X'))$  are the same.

Actually, by the connectedness of  $C_p^1(S - \alpha_1)$ , we only need to treat the case when  $p$  and  $p'$  differ by an elementary move, say,  $\alpha_2 \rightarrow \alpha'_2$ .

The idea is as follows: we find a 2-curve small circuit  $\mathcal{L}$  (not an alternating hexagon) such that four of its vertices make up an alternating sequence  $WXX'Y$  with  $W, X \in (F_v, X)$  and  $X', Y \in (F'_v, X')$  (see Fig. 7).

Suppose that  $(A(F_v), A(X))$  corresponds to a vertex of  $C(S)$  representing the curve  $\beta_1$ , and suppose that  $A(X)$  is associated to the pants decomposition  $\{\beta_1, \dots, \beta_n\}$ . We show that  $(A(F'_v), A(X'))$  also corresponds to the vertex representing  $\beta_1$ .

Since the edge  $A(W)A(X)$  is in  $(A(F_v), A(X))$ , it corresponds to a move of the form  $\star \rightarrow \beta_1$ . As  $A(W)A(X)A(X')$  is alternating (Lem. 3),  $A(X)A(X')$  corresponds to a move  $\beta_2 \rightarrow \star$ . Now, combining the facts that  $A(X)A(X')A(Y)$  is alternating

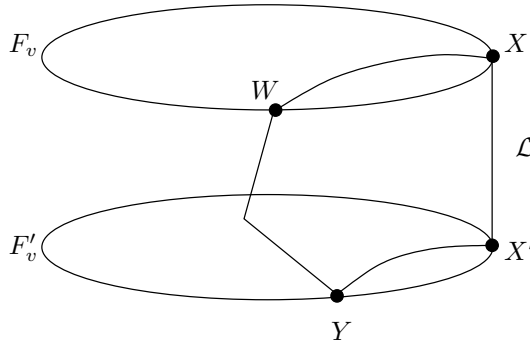

Figure 7. The 2-curve small circuit  $\mathcal{L}$

(Lem. 3) and that  $A(\mathcal{L})$  is a 2-curve small circuit (Lem. 5), it follows that the move corresponding to  $A(X')A(Y)$  is of the form  $\beta_1 \rightarrow \star$ , and so the vertex of  $C(S)$  corresponding to  $(A(F'_v), A(X'))$  represents  $\beta_1$ .

*Finding the 2-curve small circuit.* To prove that  $\phi$  is well defined, the only thing left is to show that there always exists a 2-curve small circuit  $\mathcal{L}$  as above. There are four cases to consider:

- (1)  $\alpha_1, \alpha_2$  lie on disjoint subsurfaces;
- (2)  $\alpha_1, \alpha_2$  lie on a  $\Sigma_{0,5}$ ;
- (3)  $\alpha_1, \alpha_2$  lie on a  $\Sigma_{1,2}$ , and one of  $\alpha_1, \alpha_2$ , or  $\alpha'_2$  is separating;
- (4)  $\alpha_1, \alpha_2$  lie on a  $\Sigma_{1,2}$ , and  $\alpha_1, \alpha_2$ , and  $\alpha'_2$  are nonseparating.

Note that a curve is separating on  $\Sigma_{1,2} \subset S$  if and only if it is separating on  $S$ .

*Case 1.* Let  $\mathcal{L}$  be the boundary of a square 2-cell containing  $X, X'$ .

*Case 2.* Let  $\mathcal{L}$  be the boundary of a pentagonal 2-cell containing  $X, X'$ .

*Case 3.* There are only three possibilities for the curves  $\alpha_1, \alpha_2$ , and  $\alpha'_2$  since a pants decomposition of  $\Sigma_{1,2}$  cannot have two separating curves, and two separating curves on  $\Sigma_{1,2}$  cannot differ by an elementary move:

- $\alpha_1$  is separating,  $\alpha_2$  and  $\alpha'_2$  are nonseparating;
- $\alpha_1$  and  $\alpha_2$  are nonseparating, and  $\alpha'_2$  is separating;
- $\alpha_1$  is nonseparating,  $\alpha_2$  is separating, and  $\alpha'_2$  is nonseparating.

Note that the second and third possibilities are equivalent by symmetry.

In any case, choose  $\mathcal{L}$  to be the boundary of a hexagonal 2-cell. For the first

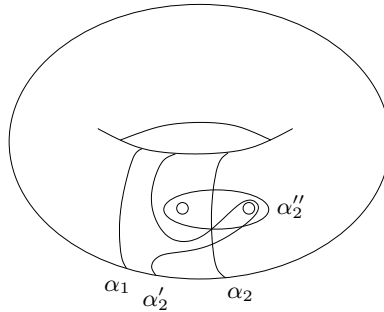

Figure 8. Reduction of case 4 to case 3

possibility, choose  $\mathcal{L}$  so that  $X$  and  $X'$  correspond to the vertices  $T$  and  $U$  in Figure 6. For the second possibility,  $X$  and  $X'$  should correspond to  $S$  and  $T$ .

*Case 4.* Since this situation does not occur in any of the circuits bounding 2-cells of  $C_P(S)$ , we reduce to case 3 by showing that any elementary move on a  $\Sigma_{1,2}$  of the form  $\{\alpha_1, \alpha_2\} \rightarrow \{\alpha_1, \alpha'_2\}$  with  $\alpha_1, \alpha_2$ , and  $\alpha'_2$  all nonseparating can be realized by a pair of elementary moves  $\{\alpha_1, \alpha_2\} \rightarrow \{\alpha_1, \alpha''_2\} \rightarrow \{\alpha_1, \alpha'_2\}$  which fall under case 3.

Topologically,  $\alpha_1$  and  $\alpha_2$  are as in Figure 8. (The complement of a pair of nonseparating curves on  $\Sigma_{1,2}$  is two copies of  $\Sigma_{0,3}$ , each with one boundary component of the  $\Sigma_{1,2}$ .) Then there is one topological possibility for  $\alpha'_2$ , as  $\alpha'_2$  differs from  $\alpha_2$  by an elementary move on  $\Sigma_{0,4} = \Sigma_{1,2} - \alpha_1$ , and the two boundary components of  $\Sigma_{1,2}$  lie on different sides of  $\alpha'_2$ . (Recall that  $\alpha'_2$  is nonseparating.) Thus  $\alpha'_2$  is also as in Figure 8. Therefore we may choose  $\alpha''_2$  as in the same figure.  $\square$

### 3.3. $\phi$ maps into $\text{Aut } C(S)$

Since  $C(S)$  has the property that every set of  $k + 1$  mutually connected vertices is the 1-skeleton of a  $k$ -simplex in  $C(S)$ , it follows that  $\text{Aut } C(S) \cong \text{Aut } C^1(S)$ . Therefore we only need to check that  $\phi(A)$  extends to an automorphism of the 1-skeleton of  $C(S)$ , that is, that  $\phi(A)$  takes vertices connected by edges to vertices connected by edges.

Suppose that  $v$  and  $w$  are vertices of  $C(S)$  associated to curves  $\alpha$  and  $\beta$  on  $S$ , and let  $X$  (a vertex of  $C^1_P(S)$ ) correspond to some pants decomposition  $\{\alpha, \beta, \gamma_3, \dots, \gamma_n\}$ . Then let  $F_v$  and  $F_w$  be the Farey graphs corresponding to the pants decompositions  $\{\star, \beta, \gamma_3, \dots, \gamma_n\}$  and  $\{\alpha, \star, \gamma_3, \dots, \gamma_n\}$ . In this case,  $(F_v, X)$  and  $(F_w, X)$  are marked Farey graphs corresponding to  $v$  and  $w$ , and which intersect at one vertex ( $X$ ). Note

that this construction is possible if and only if  $\alpha$  and  $\beta$  appear in a common pants decomposition, which is equivalent to the existence of an edge between  $v$  and  $w$ . Since intersections between Farey graphs are strictly preserved under  $A$ , and since  $\phi(A)$  is independent of choice of marked Farey graph, it follows that edges of  $C(S)$  are preserved under  $\phi(A)$ .

3.4.  $\phi$  is an isomorphism

*Multiplicativity.* Let  $A, B \in \text{Aut } C_P^1(S)$ . We show that  $\phi(AB)v = \phi(A)\phi(B)v$  for any vertex  $v$  in  $C(S)$ . By definition,  $\phi(AB)v$  is the vertex in  $C(S)$  corresponding to  $(AB(F_v), AB(X))$ , where  $(F_v, X)$  is a marked Farey graph in  $C_P(S)$  corresponding to  $v$ . On the other hand,  $\phi(B)v$  is the vertex  $w$  of  $C(S)$  corresponding to  $(B(F_v), B(X))$ , and  $\phi(A)\phi(B)v$  is the vertex of  $C(S)$  corresponding to  $(A(F_w), A(Y))$ , where  $(F_w, Y)$  is some Farey graph corresponding to  $w$ . We can choose  $(F_w, Y)$  to be  $(B(F_v), B(X))$ , and so  $\phi(A)\phi(B)v$  is the vertex corresponding to  $(AB(F_v), AB(X))$ , which is the same as  $\phi(AB)v$ .

*Surjectivity.* It suffices to show that the diagram at the beginning of this section is commutative. Let  $f \in \text{Mod}(S)$ , and let  $v$  be the vertex of  $C(S)$  associated to a curve  $\alpha_1$  on  $S$ . Then  $\phi \circ \iota \circ \theta(f)(v)$  is the vertex of  $C(S)$  corresponding to  $(\iota \circ \theta(f)(F_v), \iota \circ \theta(f)(X))$ , where  $(F_v, X)$  is a marked Farey graph corresponding to  $v$ . But if  $F_v$  and  $X$  correspond to pants decompositions  $\{\star, \alpha_2, \dots, \alpha_n\}$  and  $\{\alpha_1, \dots, \alpha_n\}$ , then  $\iota \circ \theta(f)(F_v)$  and  $\iota \circ \theta(f)(X)$  correspond to  $\{\star, f(\alpha_2), \dots, f(\alpha_n)\}$  and  $\{f(\alpha_1), \dots, f(\alpha_n)\}$ . Thus  $(\phi \circ \iota \circ \theta(f)(v)) = \eta(f)(v)$ , the vertex of  $C(S)$  representing  $f(\alpha_1)$ .

*Injectivity.* Suppose that  $\phi(A)$  is the identity in  $\text{Aut } C(S)$ , and let  $X$  be the vertex of  $C_P^1(S)$  associated to the pants decomposition  $\{\alpha_1, \dots, \alpha_n\}$ , where  $v_1, \dots, v_n$  are the vertices of  $C(S)$  associated to the  $\alpha_i$ . Denote by  $F_{v_i}$  the Farey graph corresponding to the pants decompositions

$$\{\alpha_1, \dots, \alpha_{i-1}, \star, \alpha_{i+1}, \dots, \alpha_n\}.$$

The  $(F_{v_i}, X)$  correspond to the  $v_i$ , and the  $F_{v_i}$  all intersect at the vertex  $X$  in  $C_P^1(S)$ .

Since  $(A(F_{v_1}), A(X)), \dots, (A(F_{v_n}), A(X))$  must be marked Farey graphs corresponding to  $\{\phi(A)(v_i)\} = \{v_i\}$  for  $1 \leq i \leq n$  and intersecting at one vertex, it follows that their common intersection is  $X$ . Thus  $A(X) = X$ , and so  $A$  is the identity in  $\text{Aut } C_P^1(S)$ . □

4. Proof of Theorem 2

Our goal is now to show that it is possible to recognize the 2-cells of  $C_P(S)$  simply by considering the combinatorics of  $C_P^1(S)$ , and without reference to the surface  $S$ .

This gives a complete proof of Theorem 2 and helps prove Theorem 1 for the case of  $S = \Sigma_{1,2}$ .

Again,  $S = \Sigma_{g,b}$  is an orientable surface with  $\chi(S) < 0$ , and  $n = 3g - 3 + b$  is the number of curves in a pants decomposition for  $S$ . Recall that a circuit is a subgraph of  $C_P^1(S)$  homeomorphic to a circle, and that triangles, squares, pentagons, and hexagons are circuits with the usual number of vertices.

*Triangles.* Lemma 1 says that every triangle in  $C_P^1(S)$  is the boundary of a triangular 2-cell in  $C_P(S)$ .

*Squares.* We show that square 2-cells in  $C_P(S)$  can equivalently be characterized as alternating squares in  $C_P^1(S)$ .

LEMMA 7

*Every alternating square in  $C_P^1(S)$  is the boundary of a square 2-cell in  $C_P(S)$ .*

*Proof*

Let  $P, Q, R,$  and  $S$  be the (ordered) vertices of an alternating square in  $C_P^1(S)$ . By Lemma 4,  $PQRS$  is a 2-curve small circuit, so the associated pants decompositions all contain a common set of  $n - 2$  curves, say,  $\alpha_3, \dots, \alpha_n$  (which we take to be implicit below).

Using the fact that  $PQRS$  is alternating, we have that the pattern of curves is as follows:

$$\overset{P}{\{\alpha_1, \alpha_2\}} \longrightarrow \overset{Q}{\{\alpha_1, \alpha'_2\}} \longrightarrow \overset{R}{\{\alpha'_1, \alpha'_2\}} \longrightarrow \overset{S}{\{\alpha'_1, \alpha_2\}}.$$

Note that  $\alpha_2$  must be in the pants decomposition for  $S$  since  $SPQ$  is alternating.

It remains to show that  $\alpha_1$  and  $\alpha_2$  lie on different subsurfaces in the complement of  $\alpha_3, \dots, \alpha_n$ , as per the definition of square 2-cells. Assume that  $\alpha_1$  and  $\alpha_2$  lie on a connected subsurface  $S' \subset S - \{\alpha_3, \dots, \alpha_n\}$ . Since  $S'$  has a pants decomposition of two curves ( $\{\alpha_1, \alpha_2\}$ ),  $S'$  is either  $\Sigma_{0,5}$  or  $\Sigma_{1,2}$ .

There are four topological possibilities for  $\alpha_1, \alpha_2,$  and  $\alpha'_2$ —on the  $\Sigma_{0,5}$  there is only one possibility, and on the  $\Sigma_{1,2}$  there are two cases (cases 3 and 4 of Lem. 6). It is clear that in each of the cases there is no curve  $\alpha'_1$  which intersects  $\alpha_1$  minimally and is disjoint from  $\alpha_2$  and  $\alpha'_2$ . This is a contradiction, so  $\alpha_1$  and  $\alpha_2$  lie on different subsurfaces. □

*Pentagons.* We now prove that pentagonal 2-cells in  $C_P(S)$  can be characterized as alternating pentagons in  $C_P^1(S)$ .

LEMMA 8

Every alternating pentagon in  $C_P^1(S)$  is the boundary of a pentagonal 2-cell in  $C_P(S)$ .

*Proof*

Let  $P, Q, R, S,$  and  $T$  be the (ordered) vertices of an alternating pentagon in  $C_P^1(S)$ . By Lemma 4, the pants decompositions associated to these vertices all have  $n - 2$  curves in common, say,  $\alpha_3, \dots, \alpha_n$ . (These curves are implicit in the pants decompositions below.)

Because  $PQRST$  is an alternating sequence, the pattern of curves in the pants decompositions for those vertices is

$$\overset{P}{\{\alpha_1, \alpha_2\}} \longrightarrow \overset{Q}{\{\alpha_1, \alpha'_2\}} \longrightarrow \overset{R}{\{\alpha'_1, \alpha'_2\}} \longrightarrow \overset{S}{\{\alpha'_1, \alpha''_2\}} \longrightarrow \overset{T}{\{\alpha_2, \alpha''_2\}}.$$

Note that  $\alpha_2$  must be in the pants decomposition for  $T$  since  $QPT$  is an alternating sequence.

Since curves in a pants decomposition are disjoint, we have that for the sequence  $\alpha_1\alpha'_1\alpha_2\alpha'_2\alpha''_2\alpha_1$ , curves differ by an elementary move if they are adjacent in the sequence and are disjoint otherwise. Our goal now is to show that these curves must be the ones in Figure 5.

First,  $\alpha_1$  and  $\alpha_2$  do not lie on disjoint subsurfaces ( $\alpha'_1$  has nontrivial intersection with both of them). Therefore  $\alpha_1$  and  $\alpha_2$  must lie on a  $\Sigma_{0,5}$  or  $\Sigma_{1,2}$  in  $S - \{\alpha_3, \dots, \alpha_n\}$ .

In the first case, the curves  $\alpha_2, \alpha'_2, \alpha''_2, \alpha_1,$  and  $\alpha'_1$  must be topologically as in the definition of pentagonal 2-cells in the pants complex (Fig. 5). This is because  $\alpha_1, \alpha'_1, \alpha_2, \alpha'_2$  is a *regular chain* (curves intersect twice if consecutive and are disjoint otherwise), and regular chains are topologically unique. Then  $\alpha''_2$  is the unique curve intersecting  $\alpha_1$  and  $\alpha'_2$  each twice in the complement of the other curves.

We now show that the second case cannot happen, that is, that there is no such sequence of curves on  $\Sigma_{1,2}$ .

Assume that on  $\Sigma_{1,2}$  there is a sequence  $\alpha\beta\gamma\delta\epsilon\alpha$  with the property that consecutive curves intersect minimally and other pairs are disjoint. In such a sequence, there can be at most one curve that is separating on  $\Sigma_{1,2}$  since two separating curves on  $\Sigma_{1,2}$  intersect at least four times. We consider the following two cases:

- (1) the sequence has a separating curve;
- (2) the sequence has no separating curve.

Below, we call a nonseparating curve on  $\Sigma_{1,2}$  of  $(p, q)$ -type if it is a  $(p, q)$  curve on the torus obtained by forgetting the two punctures.

*Case 1.* Suppose that there is a separating curve in the sequence, say,  $\alpha$ . It follows that the other curves in the sequence are nonseparating and that  $\alpha$  separates  $\Sigma_{1,2}$  into a  $\Sigma_{0,3}$  and a  $\Sigma_{1,1}$ . Since  $\gamma$  and  $\delta$  both have trivial intersection with  $\alpha$  and have minimal



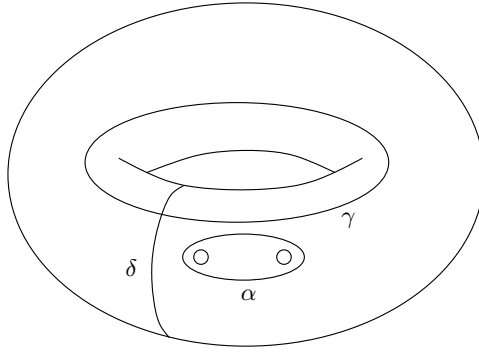

Figure 9. Case 1: The configuration for  $\alpha$  separating

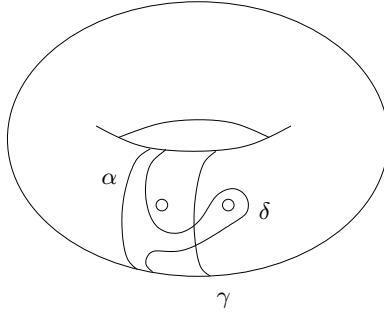

Figure 10. Case 2: The configuration for  $\alpha$  nonseparating

intersection with each other in the complement of  $\alpha$ , they must lie on the  $\Sigma_{1,1}$  and intersect once; say that  $\gamma$  and  $\delta$  are of  $(1, 0)$ - and  $(0, 1)$ -type, respectively. As  $\beta$  and  $\epsilon$  are both nonseparating curves on  $\Sigma_{1,2}$ , and  $i(\beta, \delta) = 0$ ,  $\beta$  must be of  $(0, 1)$ -type; likewise,  $\epsilon$  must be of  $(1, 0)$ -type. This implies that  $i(\beta, \epsilon) > 0$  (curves of different type intersect), so we have a contradiction (see Fig. 9).

*Case 2.* Now suppose that all the curves in the sequence are nonseparating. Since all elementary moves involving three nonseparating curves are topologically equivalent, we can assume, without loss of generality, that  $\alpha$ ,  $\gamma$ , and  $\delta$  are the curves in Figure 10.

In order to have  $i(\beta, \alpha) = 2$  and  $i(\beta, \delta) = 0$ , we must have that when  $S$  is cut along

$\alpha$  and  $\delta$ , the two components of  $\beta$  are essential arcs on the two  $\Sigma_{0,3}$ -components of  $S - (\alpha \cup \delta)$ . However, it is easy to see that on each of these components, any essential arc with endpoints on  $\alpha$  must intersect (a piece of)  $\gamma$  at least twice (in an essential way). Thus  $i(\beta, \gamma) \geq 4$ , a contradiction.  $\square$

*Hexagons.* An *almost-alternating hexagon* in  $C_P^1(S)$  is a hexagon with an alternating sequence of six vertices, and a sequence of three vertices that lie on a square in some Farey graph (and do not lie in a common triangle). Note that the boundary of a hexagonal 2-cell is an almost-alternating hexagon.

LEMMA 9

*Every almost-alternating hexagon in  $C_P^1(S)$  is the boundary of a hexagonal 2-cell in  $C_P(S)$ .*

*Proof*

Let  $P, Q, R, S, T,$  and  $U$  be (ordered) vertices of an almost-alternating hexagon, where  $UPQ$  lie in a common Farey graph. Then  $PQRSTU$  must be an alternating sequence.

Since an almost-alternating hexagon is not an alternating hexagon, then by Lemma 4, the pants decompositions associated to the vertices all have a set of  $n - 2$  curves in common, say,  $\alpha_3, \dots, \alpha_n$  (as usual, we ignore these curves below).

As  $PQRSTU$  is alternating, we get the following pattern of curves for the associated pants decompositions:

$$\overset{P}{\{\alpha_1, \alpha_2\}} \longrightarrow \overset{Q}{\{\alpha'_1, \alpha_2\}} \longrightarrow \overset{R}{\{\alpha'_1, \alpha'_2\}} \longrightarrow \overset{S}{\{\alpha''_2, \alpha'_2\}} \longrightarrow \overset{T}{\{\alpha''_2, \alpha''_1\}} \longrightarrow \overset{U}{\{\alpha_2, \alpha''_1\}}.$$

Note that the pants decomposition for  $U$  must have the curve  $\alpha_2$  since  $UPQ$  lies in a Farey graph.

The goal now is to show that the curves must be as the curves corresponding to a hexagonal 2-cell (Fig. 6). We take the following steps:

- (1)  $\alpha_1, \alpha_2$  do not lie on disjoint subsurfaces;
- (2)  $\alpha_1, \alpha_2$  do not lie on a  $\Sigma_{0,5}$  (and hence they lie on a  $\Sigma_{1,2}$ );
- (3)  $\alpha_2$  is nonseparating on the  $\Sigma_{1,2}$ ;
- (4)  $\alpha_1$  is nonseparating on the  $\Sigma_{1,2}$ ;
- (5)  $\alpha'_1$  (and hence  $\alpha''_1$ ) is separating on the  $\Sigma_{1,2}$ ;
- (6) the choices of  $\alpha_1, \alpha'_1, \alpha''_1, \alpha_2, \alpha'_2, \alpha''_2$  on  $\Sigma_{1,2}$  are topologically unique.

*Step 1.* The curves  $\alpha_1$  and  $\alpha_2$  cannot lie on disjoint subsurfaces since there is a chain

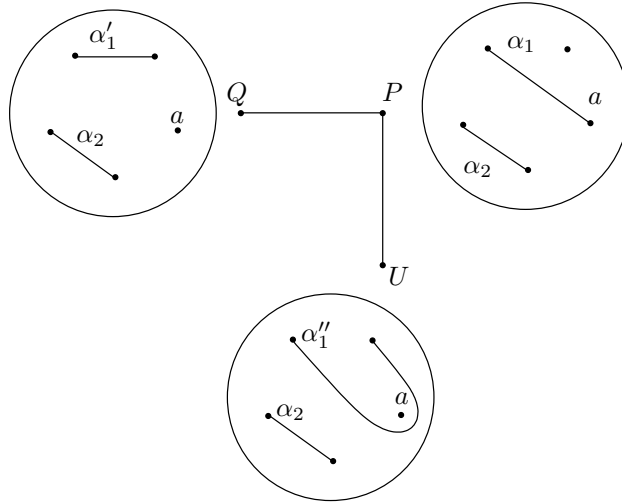

Figure 11. Step 2: The configuration for  $\alpha_1$  and  $\alpha_2$  on a  $\Sigma_{0,5}$

of curves connecting them which are disjoint from  $\alpha_3, \dots, \alpha_n$ :

$$\alpha_1 \longrightarrow \alpha''_1 \longrightarrow \alpha'_2 \longrightarrow \alpha_2.$$

*Step 2.* Assume that  $\alpha_1$  and  $\alpha_2$  lie on a  $\Sigma_{0,5}$  in the complement of  $\alpha_3, \dots, \alpha_n$ . Since  $P, Q$ , and  $U$  are the vertices of a square in a Farey graph, and  $\alpha_2$  appears in all three associated pants decompositions, the aforementioned Farey graph is  $C^1_P(\Sigma_{0,4})$ , where  $\Sigma_{0,4} = \Sigma_{0,5} - \alpha_2$ . Then since any two squares in  $C^1_P(\Sigma_{0,4})$  are topologically equivalent, it follows that the pants decompositions associated to  $P, Q$ , and  $U$  are as in Figure 11. (In the figure, a boundary component is represented by a puncture, and a curve is represented by an arc; to recover the curve, take a boundary of a small neighborhood of the arc.)

The edges  $QR$  and  $UT$  (note directions) correspond to the elementary moves  $\alpha_2 \rightarrow \alpha'_2$  and  $\alpha_2 \rightarrow \alpha''_2$ . Since all elementary moves on  $\Sigma_{0,5}$  are topologically equivalent, both  $\alpha'_2$  and  $\alpha''_2$  must be represented by arcs that have an endpoint at the puncture  $a$  (see Fig. 11). It follows that  $i(\alpha'_2, \alpha''_2) > 0$ . This is a contradiction since  $\alpha_2$  and  $\alpha''_2$  appear together in the pants decomposition associated to the vertex  $S$ .

*Step 3.* If we assume that  $\alpha_2$  is separating on  $\Sigma_{1,2}$ , then it separates  $\Sigma_{1,2}$  into a  $\Sigma_{0,3}$  and a  $\Sigma_{1,1}$ . Then  $\{\alpha_1\}, \{\alpha'_1\}$ , and  $\{\alpha''_1\}$  are pants decompositions of the  $\Sigma_{1,1}$ , whose associated vertices in  $C^1_P(\Sigma_{1,1})$  lie on a square (but not a triangle). Then, topologically,

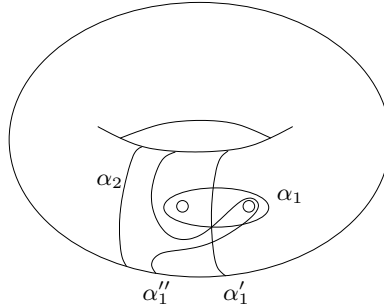

Figure 12. Step 4: The configuration for  $\alpha_1$  separating

$\alpha_1''$ ,  $\alpha_1$ , and  $\alpha_1'$  are the (1, 0)-, (2, 1)-, and (1, 1)-curves on the  $\Sigma_{1,1}$ , so they are of the same three types on the  $\Sigma_{1,2}$  (see Lem. 8). Since  $\alpha_2$  is separating,  $\alpha_2'$  and  $\alpha_2''$  must both be nonseparating. (They must have intersection number with  $\alpha_2$  no more than 2.) Also, because  $i(\alpha_2', \alpha_1') = 0$  (the two form a pants decomposition), it follows that  $\alpha_2'$  must be of type (1, 1). Likewise,  $\alpha_2''$  must be of type (1, 0). However, since  $\alpha_2'$  and  $\alpha_2''$  must make up a pants decomposition of  $\Sigma_{1,2}$ , they must have trivial intersection; but curves of different type always have nontrivial intersection, a contradiction.

*Step 4.* Assume that  $\alpha_1$  is separating on the  $\Sigma_{1,2}$ . Since all pants decompositions containing a separating curve are topologically equivalent, we assume that  $\alpha_1$  and  $\alpha_2$  are as in Figure 12.

Now, there is a unique choice for  $\alpha_1'$ , as  $i(\alpha_1', \alpha_1) = 2$  and  $i(\alpha_1', \alpha_2) = 0$ . Since  $\alpha_1''$  must be part of a square (but not a triangle) with the vertices of  $C_P^1(\Sigma_{0,4})$  associated to  $\alpha_1$  and  $\alpha_1'$ , the choice of  $\alpha_1''$  is topologically unique.

The curve  $\alpha_2'$  must have trivial intersection with  $\alpha_1'$ , and it must differ from both  $\alpha_1''$  and  $\alpha_2$  by elementary moves. By the same argument as in case 2 of Lemma 8, there is no such  $\alpha_2'$ , so we have a contradiction.

*Step 5.* Without loss of generality,  $\alpha_1$  and  $\alpha_2$  are the curves in Figure 13. If we assume that  $\alpha_1'$  is nonseparating on the  $\Sigma_{1,2}$ , then since  $\{\alpha_1, \alpha_2\} \rightarrow \{\alpha_1', \alpha_2\}$  is an elementary move, the choice for  $\alpha_1'$  is topologically unique.

In order for  $\alpha_1'$ ,  $\alpha_1$ , and  $\alpha_1''$  to lie on a square (but not a triangle) in the Farey graph  $C_P^1(\Sigma_{0,4}) = C_P^1(S - \alpha_2)$ , and for  $\alpha_1$  to differ from  $\alpha_1'$  and  $\alpha_1''$  by elementary moves, we must have  $i(\alpha_1, \alpha_1') = i(\alpha_1, \alpha_1'') = 2$  and  $i(\alpha_1', \alpha_1'') = 4$ . The only such configuration is shown in Figure 13.

Again, we must have  $i(\alpha_2', \alpha_1') = 0$ , and  $\alpha_2'$  must differ from  $\alpha_1''$  and  $\alpha_2$  by ele-

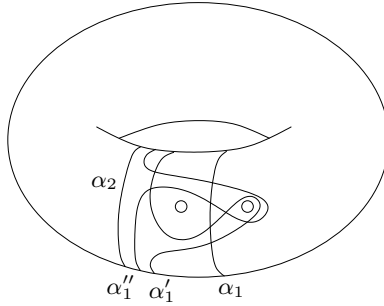

Figure 13. Step 5: The configuration for  $\alpha_1'$  nonseparating

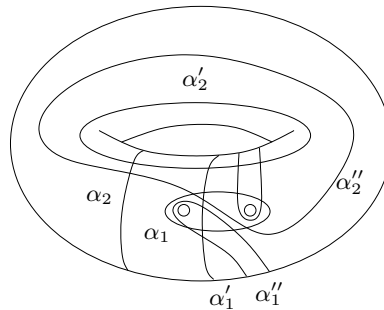

Figure 14. Step 6: The unique configuration for almost-alternating hexagons

mentary moves. By the same argument as in case 2 of Lemma 8, there is no such  $\alpha_2'$ , and we have a contradiction.

*Step 6.* Starting with  $\alpha_1$  and  $\alpha_2$  (both nonseparating), we can assume that they are as in Figure 14. As above,  $i(\alpha_1, \alpha_1') = i(\alpha_1, \alpha_1'') = 2$ ,  $i(\alpha_1', \alpha_1'') = 4$ , and  $i(\alpha_1', \alpha_2) = i(\alpha_1'', \alpha_2) = 0$ . The only such topological configuration is shown in Figure 14.

Finally, there are unique choices for  $\alpha_2'$  and  $\alpha_2''$ , as  $\alpha_2'$  must have trivial intersection with  $\alpha_1'$  and must have minimal intersection with  $\alpha_2$  and  $\alpha_1''$ , while  $\alpha_2''$  must have trivial intersection with  $\alpha_1''$  and must have minimal intersection with  $\alpha_2$  and  $\alpha_1'$ .  $\square$

Lemmas 1, 7, 8, and 9 say that each kind of 2-cell in  $C_p^1(S)$  can be recognized com-

pletely in terms of the combinatorics of  $C_p^1(S)$ . Therefore  $\text{Aut } C_p^1(S)$  and  $\text{Aut } C_p(S)$  are canonically isomorphic, and Theorem 2 is proved.  $\square$

### 5. Theorem 1 for $S = \Sigma_{1,2}$

As stated in Theorem 3, the exceptional feature of  $\Sigma_{1,2}$  is that the natural map  $\eta : \text{Mod}(\Sigma_{1,2}) \rightarrow \text{Aut } C(\Sigma_{1,2})$  is not a surjection. More precisely, the image of  $\eta$  is  $\text{Aut}^* C(\Sigma_{1,2})$ , the subgroup of  $\text{Aut } C(\Sigma_{1,2})$  consisting of elements that preserve the set of vertices associated to nonseparating curves on  $\Sigma_{1,2}$ . Therefore the only added complication is to show that the image of  $\phi$  (as defined in Sec. 3.1) lies in  $\text{Aut}^* C(\Sigma_{1,2})$ .

Let  $v$  be a vertex of  $C(\Sigma_{1,2})$  representing a nonseparating curve  $\alpha$ , and let  $X$  in  $C_p^1(S)$  represent  $\{\alpha, \beta\}$ , a pants decomposition with  $\beta$  nonseparating. This gives rise to a marked Farey graph  $(F_v, X)$  corresponding to  $v$ . Note that there is a hexagonal 2-cell containing  $X$  with the property that  $X$  corresponds to the vertex  $P$  in Figure 6. The vertex  $P$  is distinguished as the middle vertex of the nonalternating sequence in an almost-alternating hexagon. This construction is possible only for  $\alpha$  nonseparating. Since almost-alternating hexagons and nonalternating sequences are preserved by automorphisms of  $C_p^1(S)$  (Lems. 3 and 9), and since  $\phi$  is independent of the choice of marked Farey graphs, we are done.

*Acknowledgments.* The author thanks Benson Farb for suggesting and discussing the problem, as well as Jeff Brock, Kevin Wortman, and Feng Luo for enlightening conversations. The referee has been extremely helpful with many aspects of the paper.

### References

- [1] J. F. BROCK, *The Weil-Petersson metric and volumes of 3-dimensional hyperbolic convex cores*, J. Amer. Math. Soc. **16** (2003), 495–535. MR 1969203
- [2] J. L. HARER, *The virtual cohomological dimension of the mapping class group of an orientable surface*, Invent. Math. **84** (1986), 157–176. MR 0830043
- [3] W. J. HARVEY, “Geometric structure of surface mapping class groups” in *Homological Group Theory (Durham, England, 1977)*, London Math. Soc. Lecture Note Ser. **36**, Cambridge Univ. Press, Cambridge, 1979, 255–269. MR 0564431
- [4] A. HATCHER, P. LOCHAK, and L. SCHNEPS, *On the Teichmüller tower of mapping class groups*, J. Reine Angew. Math. **521** (2000), 1–24. MR 1752293
- [5] A. HATCHER and W. THURSTON, *A presentation for the mapping class group of a closed orientable surface*, Topology **19** (1980), 221–237. MR 0579573
- [6] N. V. IVANOV, “Automorphisms of complexes of curves and of Teichmüller spaces” in *Progress in Knot Theory and Related Topics*, Travaux en Cours **56**, Hermann, Paris, 1997, 113–120. MR 1603146

- [7] M. KORKMAZ, *Automorphisms of complexes of curves on punctured spheres and on punctured tori*, *Topology Appl.* **95** (1999), 85 – 111. MR 1696431
- [8] F. LUO, *Automorphisms of the complex of curves*, *Topology* **39** (2000), 283 – 298. MR 1722024
- [9] H. A. MASUR and Y. N. MINSKY, *Geometry of the complex of curves, I: Hyperbolicity*, *Invent. Math.* **138** (1999), 103 – 149. MR 1714338
- [10] H. MASUR and M. WOLF, *The Weil-Petersson isometry group*, *Geom. Dedicata* **93** (2002), 177 – 190. MR 1934697
- [11] Y. N. MINSKY, “A geometric approach to the complex of curves on a surface” in *Topology and Teichmüller Spaces (Katinkulta, Finland, 1995)*, World Sci., River Edge, N.J., 1996, 149 – 158. MR 1659683

Department of Mathematics, University of Utah, 155 South 1440 East, Salt Lake City, Utah 84112-0090, USA; margalit@math.utah.edu